

**Control panel for air to water Inverter heat pump**

**Pannello di controllo per pompa di calore Inverter aria / acqua**

**Panneau de contrôle pour pompe à chaleur Inverter air / eau**



# CONTENTS

- 1 - Presentation of control elements ..... 2
- 2 - Operation..... 3
- 3 - Settings ..... 5
- 4 - Graphs..... 11

## 1 - PRESENTATION OF CONTROL ELEMENTS

### CONTROL PANEL

#### BUTTONS

-  BUTTON ON/OFF - BACK TO THE PREVIOUS MENU
-  BUTTON UP
-  BUTTON DOWN
- SET** SETTINGS BUTTON

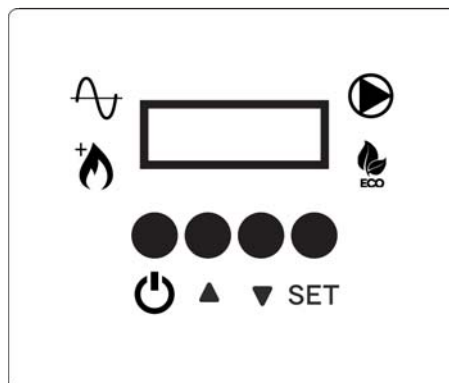

#### DISPLAY - MAIN SCREEN WITH UNIT SWITCHED ON

- ON: HEAT PUMP IN OPERATION
- OFF: HEAT PUMP STOPPED
- BLINKING: HEAT PUMP IS STARTING

- ON: PUMP IN OPERATION
- OFF: PUMP STOPPED

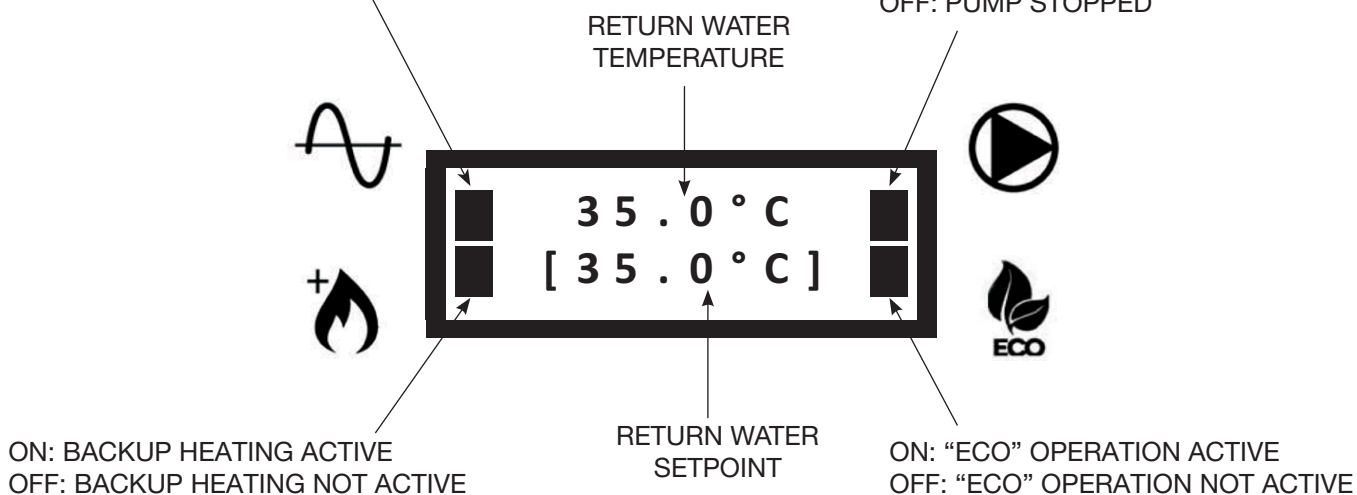

### 2.1 - SWITCHING THE UNIT ON/OFF

- When the unit is powered, the following screen appears:



- To turn on the unit, press and hold the button  for 3 seconds. The following two screens will appear sequentially:

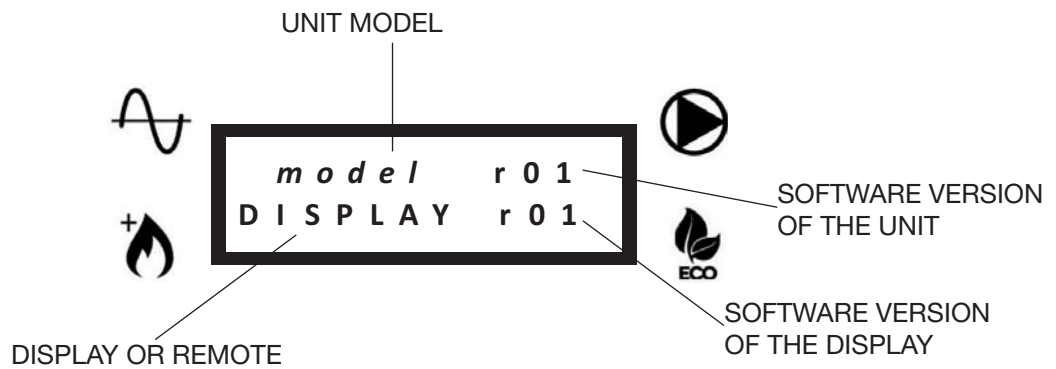

- Then the main screen will appear:



- To turn off the unit, press and hold the button  for 3 seconds. The following two screens will appear sequentially:

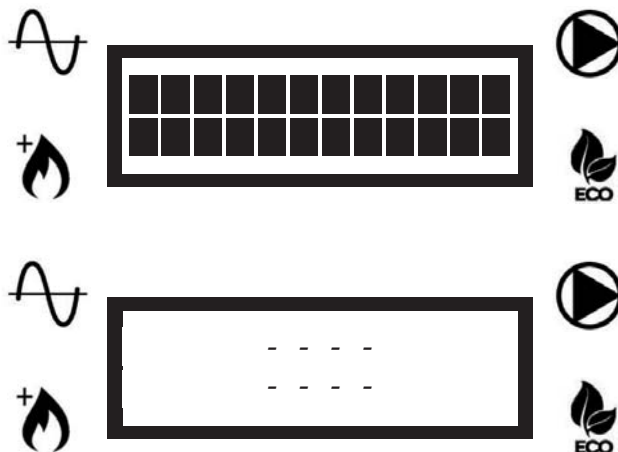

**NOTE:** Once the unit has been switched off, the water pump may continue to operate in order to prevent frost in the pipes.

## 2.2 - SETPOINT MODIFICATION (RETURN WATER TO THE UNIT)

If the fixed setpoint has been selected (P05 = 1, see parameter list), you can set the setpoint manually. To change the setpoint, press the buttons ▲ or ▼ until the desired setpoint is displayed in the second line.

## 2.3 - KEYBOARD LOCKED / UNLOCKED

To lock the keyboard so that it is not possible to accidentally press the buttons, press the buttons ▲ and ▼ simultaneously for 3 seconds.

The following screen will appear:

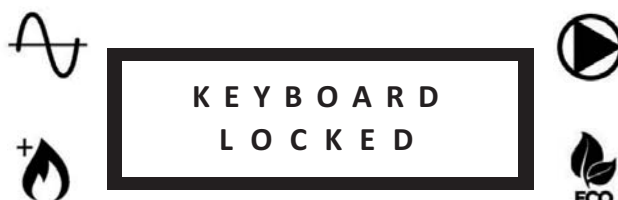

Repeat the same operation to unlock the keyboard. The following screen will appear:

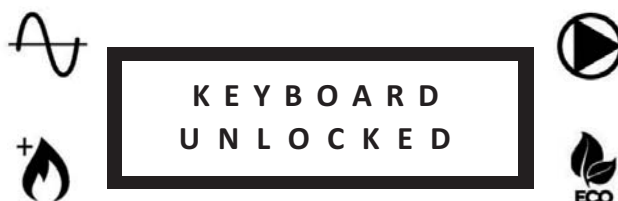

## 2.4 - DEFROST



During the defrost cycles of the unit, the following screen will appear:





The first line will display the return water temperature.









### 3.1 - USER PARAMETERS SETTING - LEVEL 1

- Press the **SET** button once to enter the menu level 1 (see table):

Name	Description	Notes
Pump Speed selection	Select the water pump speed and read back the corresponding water flow	Once desired speed has been selected, press button  to confirm the selection
Water flow	Water flow level bar	
Sensors reading	List of main sensors reading	RWT, SWT, OAT, Water Flow, Pump Speed
Working mode selection	HEAT: heating mode selected COOL: cooling mode selected	Selection available only if P14 = 1 See parameter P04
Error List	List of last 10 errors	Hold button  for 5 seconds to delete the list (possible only if P07 = 1)
Language selection	0= French 1= English 2= Italian	See parameter P08

- Utilise buttons  or  to select the desired parameter.
- Press **SET** to visualise or modify the selected parameter.
- Press **SET** to confirm any changes.
- Press the button  to return to the previous menu.

### 3.2 - AUTHORIZED SERVICE CENTER PARAMETERS SETTING - LEVEL 2

- Press and hold **SET** button for 3 seconds to enter the menu level 2 (see table on the next page).
- The parameter for the setting of the pump mode will be displayed.
- Press **SET** to modify the pump mode (see P03) or press buttons  or  to enter the parameter list (the list is accessible only by password).
- Enter the password and confirm with the **SET** button.
- Press buttons  or  to scroll through the parameters.
- Press **SET** to visualise the selected parameter.
- Press and hold **SET** button for 3 seconds to modify the parameter. The parameter value will blink to indicate the change in progress.
- Press buttons  or  to change the parameter value.
- Press **SET** to confirm or  to cancel.
- Press the button  to return to the previous menu.

#### LEGEND OF ACRONYMS (CONTAINED IN THE PARAMETER TABLES)

DHW: DOMESTIC HOT WATER

RWT: RETURN WATER TEMPERATURE

SWT: SUPPLY WATER TEMPERATURE

OAT: OUTDOOR AIR TEMPERATURE

ICT1: OUTLET (HEAT) / INLET (COOL) HEAT EXCHANGER (PLATE-TYPE)

ICT2: INLET (HEAT) / OUTLET (COOL) HEAT EXCHANGER (PLATE-TYPE)

OCT: OUTDOOR COIL TEMPERATURE

CDT: COMPRESSOR DISCHARGE TEMPERATURE

CTST: COMPRESSOR TOP SHELL TEMPERATURE

ICP: CONDENSING PRESSURE (HEAT) / EVAPORATING PRESSURE (COOL)

C/E: CONDENSING TEMPERATURE (HEAT) / EVAPORATING TEMPERATURE (COOL)

## 3.2.1 - SETTING OF GENERAL PARAMETERS

Num.	Description	Unit	Default value			Range		Increment	Value description	Notes
			Floor	Fan coils	Radiators	Min.	Max.			
-	Sensors reading		Read only							List of all the sensors value
P02	On-Off hysteresis	°C	1.5	1.5	1.5	0.5	10	0.5	Hysteresis of heat pump restart on the return water temperature	See graph "ON/OFF HYSTERESIS"
P03	Water pump mode	-	Auto (0)	Auto (0)	Auto (0)	Auto (0)	ON (1)	1	AUTO= Auto mode ON= Water pump always ON	
P04	Working mode	-	Heat (0)	Heat (0)	Heat (0)	Heat (0)	Cool (1)	1	HEAT= heating mode selected COOL= cooling mode selected	Selection available only if P14 = 1
P05	Setpoint mode	-	0	0	0	0	1	1	0= Automatic setpoint (climatic curve) 1= Fixed setpoint (user selection)	In 2-zones application, if auto mode is selected the warmest (heating mode) or the coldest (cooling mode) setpoint is selected
P06	Secondary water pump	-	0	0	0	0	1	1	0= Unit pump only 1= Secondary pump installed (primary/secondary circuit)	
P07	Error list reset enable	-	0	0	0	0	1	1	0= Error list reset forbidden 1= Error list reset allowed	If P07 = 1 go to the error list and hold the button ▲ for 5 seconds to clear the list
P08	Language	-	English (1)	English (1)	English (1)	0	2	1	0= French 1= English 2= Italian	
P09	Backup heating mode	-	0	0	0	0	3	1	0= Backup heating disabled 1/2/3= External backup heating enabled	
P10	Backup heating delay	Min.	20	20	20	5	120	1	Time of heat pump functioning before backup heating activation	Valid only if P40 < OAT < P12 See graph "OPERATING RANGE OF HEAT PUMP/BACKUP HEATING"
P11	Boost mode	-	0	0	0	0	1	1	0= Boost mode disabled 1= Boost mode activated	If P11 = 1, backup heating (according to P09) will be immediately activated up to the setpoint, then P11 is automatically reset to 0
P12	Backup heating threshold	°C	0	0	0	P40	+35	1	Heating mode: OAT > P12: backup heating disabled OAT < P12: backup heating enabled	See graph "OPERATING RANGE OF HEAT PUMP/BACKUP HEATING"
P13	DHW valve delay	Sec.	15	15	15	15	300	5	Time to move the DHW valve from one position to the other	

Num.	Description	Unit	Default value			Range		Increase	Value description	Notes
			Floor	Fan coils	Radiators	Min.	Max.			
P14	Working mode selection	-	0	0	0	0	1	0= Working mode selected by thermostat 1= Working mode selected with P04		
P20	Alarm contact function	-	0	0	0	0	1	0= Alarm 1= Defrost 2= Alarm or defrost 3= DHW 4= Alarm or DHW 5= Defrost or DHW 6= Alarm or defrost or DHW		
P21	DHW contact function	-	0	0	0	0	1	0= DHW 1= Secondary setpoint	If P21= 0, when DHW contact is closed the unit will automatically manage the DHW production. If P21 = 1, when DHW contact is closed the unit will use the secondary setpoint P22 (heating only).	
P22	Secondary setpoint	°C	50	50	50	20	0,5	Setpoint used if P21 = 1 and DHW contact is closed		
P23	Maximum DHW production time	h	5	5	5	1	1			
P30	Minimum heating time of the system	Min.	60	60	60	10	5	Minimum system heating time after DHW production	Valid if there is a system request	
P31	Antifreeze function threshold	°C	1	1	1	-20	+35	If OAT < P31, antifreeze function is activated in order to avoid water freezing in the pipings.	See graph "ANTIFREEZE FUNCTION"	
P32	Antifreeze threshold (P31) hysteresis	°C	1	1	1	1	0,5	Hysteresis on P31	See graph "ANTIFREEZE FUNCTION"	
P33	Minimum water flow	m <sup>3</sup> /h	0,3	0,4	0,4	0,3	0,1	Minimum water flow threshold	If water flow drops below P33, water flow error will appear and the unit will stop	
P40	Heat pump threshold	°C	-20	-20	-20	-20	P12	Heating mode: OAT < P40: heat pump disabled OAT > P40: heat pump enabled	See graph "OPERATING RANGE OF HEAT PUMP/BACKUP HEATING"	
P41	Defrost	-	0	0	0	0	1	If P41 is set to 1 and unit is running in heating mode, a defrost will start. At the end of defrost cycle P41 is automatically reset to 0		
P50	Factory default reset	-	0	0	0	0	1	If P50 is set to 1, all parameters will be reset to the default value. After the reset has been done, P50 is automatically reset to 0		
P51	Maximum heat pump setpoint	°C	58	58	58	20	0,5	Maximum setpoint for the heat pump. If calculated setpoint is > P51, heat pump will stop when P51 is reached and setpoint can only be reached with backup heating (if enabled).		
P52	Return water minimum temperature	°C	15	15	15	5	20	Heating mode: RWT < P52: heat pump disabled and backup heating activated. RWT > P52: heat pump enabled.	See graph "RETURN WATER MINIMUM TEMPERATURE PROTECTION"	

Num.	Description	Unit	Default value			Range		Increase	Value description	Notes
			Floor	Fan coils	Radiators	Min.	Max.			
P53	Special command	-	0	0	0	0	999	1	0= Special command disabled 1= Air purge function activation	
P60	Eco mode power limit	%	75	75	75	30	100	1		
P61	Eco mode enable	-	1	1	1	0	1	1	0= Eco mode command disabled 1= Eco mode command enabled	
P62	DHW mode	-	0	0	0	0	2	1	0= ECO 1= AUTO 2= FAST	ECO: maximum efficiency FAST: maximum yield AUTO: ECO if ON/OFF contact is open FAST if ON/OFF contact is closed



### 3.2.2 - SETTING OF SINGLE ZONE OR ZONE 1

- To set the single zone or zone 1 use parameters from P101 to P161 (see table).

Num.	Description	Unit	Default value			Range		Increase	Value description	Notes
			Floor	Fan coils	Radiators	Min.	Max.			
P101	Plant type (single zone or zone 1)	-		0		0	2	1	0= Underfloor 1= Fan coil 2= Low temperature radiators	When P101 is changed, P105 / P106 / P120 / P121 P123 are reset to the corresponding default value.
P105	Maximum climatic curve setpoint (single zone or zone 1)	°C	35	45	50	30	55	0,5		Only for heating mode See graph "CLIMATIC CURVE"
P106	Minimum climatic curve setpoint (single zone or zone 1)	°C	20	35	40	20	40	0,5		See graph "CLIMATIC CURVE"
P120	Temperature for maximum setpoint (single zone or zone 1)	°C	-7	-7	-7	-20	P121	0,5		Set to the minimum expected regional temperature See graph "CLIMATIC CURVE"
P121	Temperature for minimum setpoint (single zone or zone 1)	°C	17	17	17	P120	+35	0,5		If P121 < P120, P120 is automatically set to P121 See graph "CLIMATIC CURVE"
P123	Cooling setpoint (single zone or zone 1)	°C	23	12	-	10	30	0,5		In cooling mode the setpoint is fixed and it corresponds to P123
P130	Calculated setpoint (single zone or zone 1)	°C	Read only							
P131	Lowest cooling setpoint with 0-10V control (single zone or zone 1)	°C	23	12	-	10	P132	0,5		Active only if P150 = 1, it corresponds to a signal of 10V See graph "0-10V CONTROL"
P132	Highest cooling setpoint with 0-10V control (single zone or zone 1)	°C	30	30	-	P131	30	0,5		Active only if P150 = 1, it corresponds to a signal of 0V. If P132 < P131, P132 is automatically set to P131 See graph "0-10V CONTROL"
P150	0-10V signal function (single zone or zone 1)	-	0	0	0	0	4	1		If P150 = 3 or 4, 0-10V signal is read on outdoor unit only and signals on zone 1 and 2 will be ignored See graph "0-10V CONTROL"
P151	Maximum 0-10V setpoint shift	°C	5	5	5	1	10	0,5		Active only in heating mode and if P150 = 1. It represents the shift on the setpoint with a signal of 10V. (See graph "0-10V CONTROL")
P152	Manual setpoint shift	°C	0	0	0	0	10	0,5		Climatic curve manual setpoint shift in heating mode
P160	Mixing valve delay	sec	60	60	60	30	300	5		
P161	Mixing valve control type	-	0	0	0	0	1	1		0 = 230 Vac control (2 or 3 points) 1 = 0-10V control

## 3.2.3 - SETTING OF ZONE 2

- To set zone 2 use parameters from P201 to P261.

Num.	Description	Unit	Default value			Range		Increase	Value description	Notes
			Floor	Fan coils	Radiators	Min.	Max.			
P201	Plant type (zone 2)	-		0		0	2	1	0 = Underfloor 1 = Fan coil 2 = Low temperature radiators	When P201 is changed, P205 / P206 / P220 / P221 P223 are reset to the corresponding default value.
P205	Maximum climatic curve setpoint (zone 2)	°C	35	45	50	30	55	0,5		Only for heating mode See graph "CLIMATIC CURVE"
P206	Minimum climatic curve setpoint (zone 2)	°C	20	35	40	20	40	0,5		See graph "CLIMATIC CURVE"
P220	Temperature for maximum setpoint (zone 2)	°C	-7	-7	-7	-20	P221	0,5		Set to the minimum expected regional temperature See graph "CLIMATIC CURVE"
P221	Temperature for minimum setpoint (zone 2)	°C	17	17	17	P220	+35	0,5		If P221 < P220, P220 is automatically set to P221 See graph "CLIMATIC CURVE"
P223	Cooling setpoint (zone 2)	°C	23	12	-	10	30	0,5		In cooling mode the setpoint is fixed and it corresponds to P223
P230	Calculated setpoint (zone 2)	°C	-	-	-	-	Read only			
P231	Lowest cooling setpoint with 0-10V control (zone 2)	°C	23	12	-	10	P232	0,5		Active only if P250 = 1, it corresponds to a signal of 10V. See graph "0-10V CONTROL"
P232	Highest cooling setpoint with 0-10V control (zone 2)	°C	30	30	-	P231	30	0,5		Active only if P250 = 1, it corresponds to a signal of 0V. If P232 < P231, P232 is automatically set to P231 See graph "0-10V CONTROL"
P250	0-10V signal function (zone 2)	-	0	0	0	0	2	1		If P250 = 3 or 4, 0-10V signal is read on outdoor unit only and signals on zone 1 and 2 will be ignored. See graph "0-10V CONTROL"
P251	Maximum 0-10V setpoint shift	°C	5	5	5	1	10	0,5		Active only in heating mode and if P250 = 1. It represents the shift on the setpoint with a signal of 10V. (See graph "0-10V CONTROL")
P252	Manual setpoint shift	°C	0	0	0	0	10	0,5		Climatic curve manual setpoint shift in heating mode
P260	Mixing valve delay	sec	60	60	60	30	300	5		
P261	Mixing valve control type	-	0	0	0	0	1	1		0 = 230 Vac control (2 or 3 points) 1 = 0-10V control

## 4.1 - ON/OFF HYSTERESIS

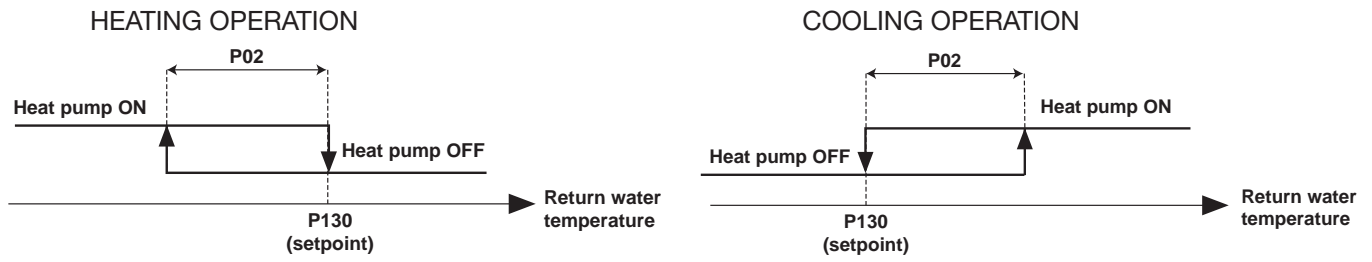

## 4.2 - OPERATING RANGE OF HEAT PUMP/BACKUP HEATING

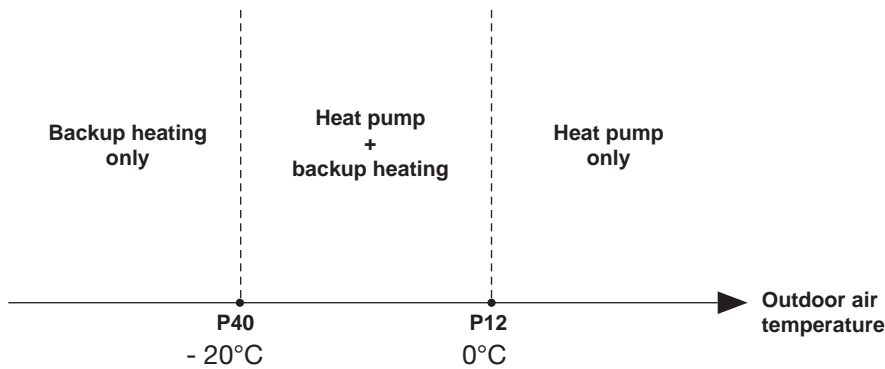

### NOTE

The operation of the heat pump is prevented if the outside temperature is below the stop threshold (parameter 40). Only the backup heating is authorized.

## 4.3 - CLIMATIC CURVE (HEATING MODE)

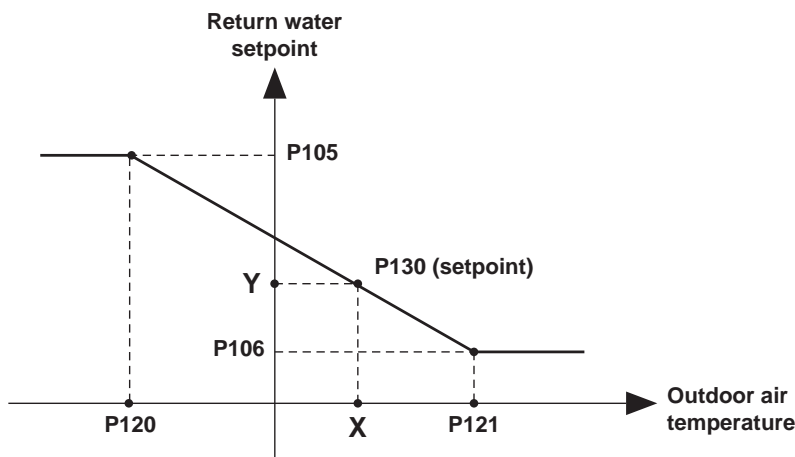

## 4.4 - ANTIFREEZE FUNCTION

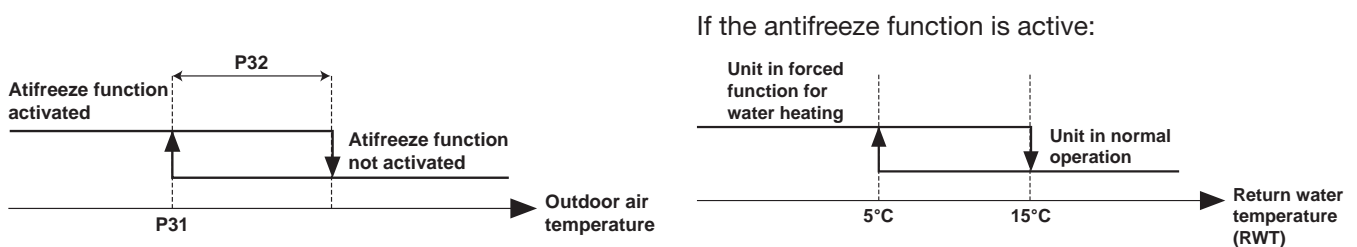

4.5 - 0-10V CONTROL

Thermal load  
(P150 = 1)

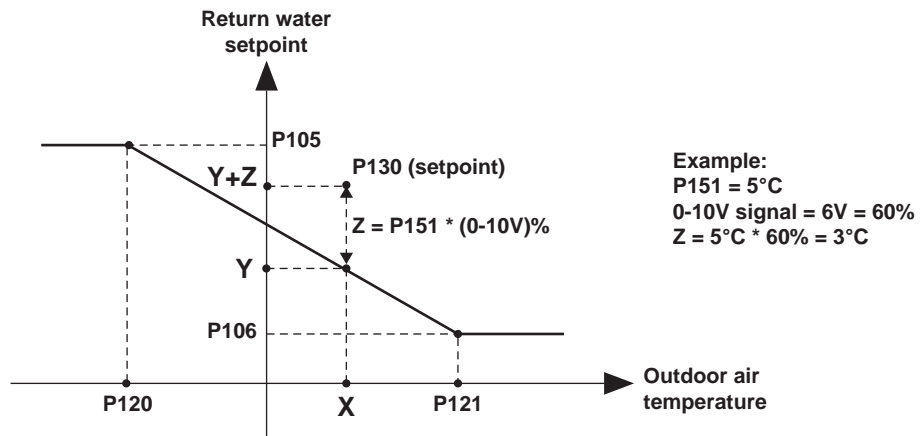

Setpoint command  
(P150 = 2)

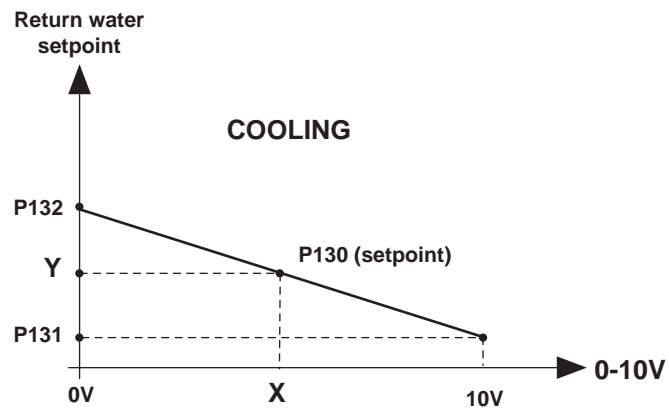
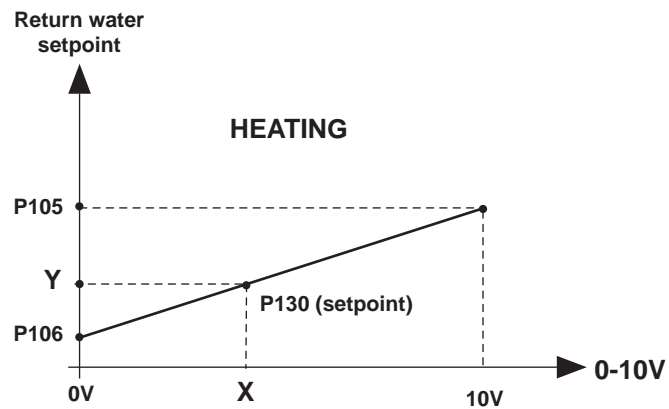

**NOTE:** The graphs referring to the parameters of zone 1 are the same for zone 2 with the corresponding parameters.

## 4.6 - RETURN WATER MINIMUM TEMPERATURE PROTECTION

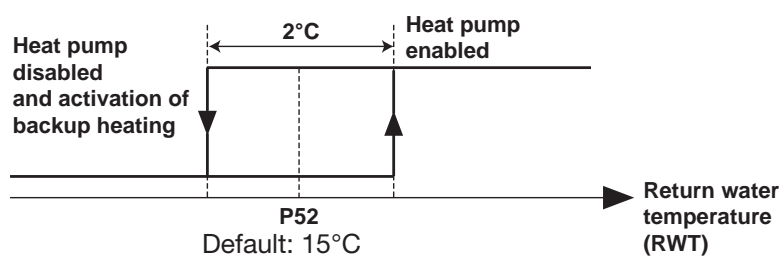

### NOTE

A water temperature safety (system return) prevents the heat pump from operating if the temperature is lower than the heating authorization threshold with the heat pump (parameter 52). In this case, only the electric backup heating is authorized to raise the water temperature and allow the heat pump to operate, at any external temperature.

If the backup heating is not installed (P09 = 0) this protection is not active.

For this reason, the heat pump stops and the display will show the writing: **RWT < P52**

---

**argoclima** s.p.a.

Via Alfeno Varo, 35 - 25020 Alfianello - BS - Italy

Tel. +39 0331 755111 - Fax +39 0331 755501

[www.argoclima.com](http://www.argoclima.com)